

Let's Talk About Repeaters!

And Duplexers, too



Dave Andrus – K7DAA
February 22, 2024

Simplified K7DAA Repeater

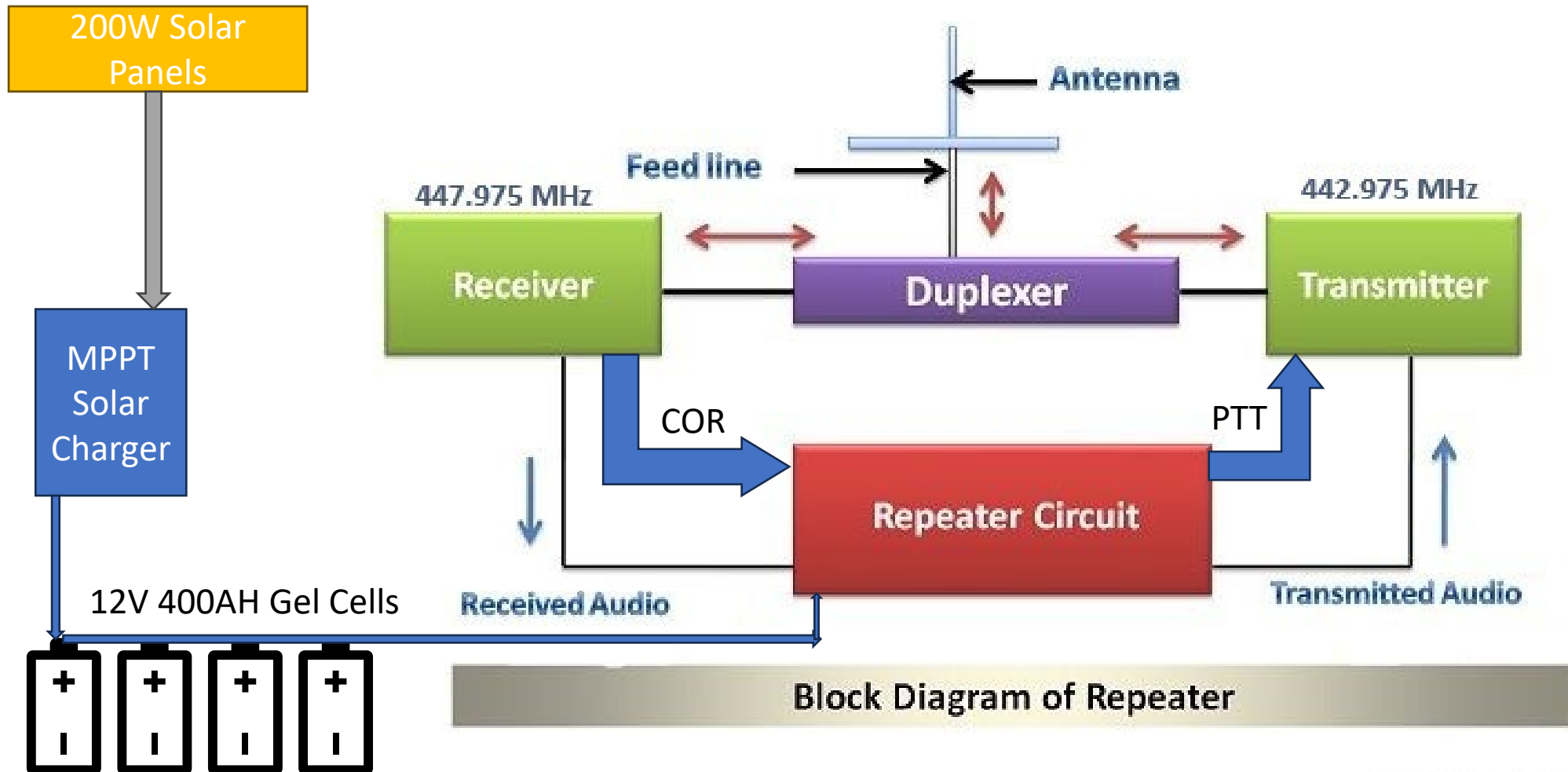

Motorola
Duplexers
for 420-470
MHz at the
K7DAA Site



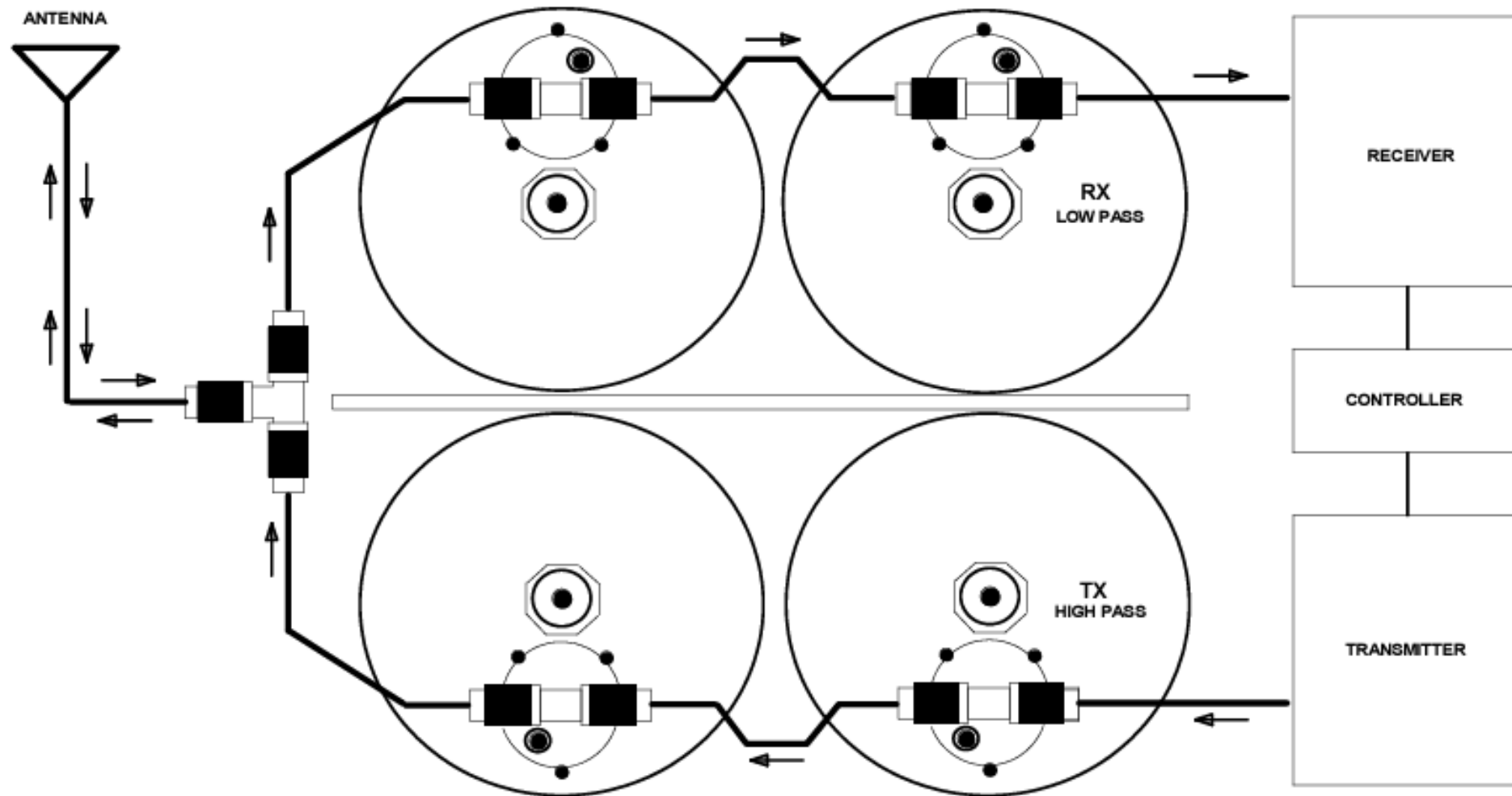

Typical Four Cavity Duplexer

A Duplexer Keeps the Transmitter Power Just 5 MHz or 600 kHz (440 or 146 MHz) Away from De-Sensitizing its Receiver.
=====

The receiver is listening for signals as low as -125 dBm while also transmitting a power as high as +50 dBm (100 watts) at the same time. So we need 175 dB of isolation!
=====

The duplexer does NOT provide all of the isolation—typically about 80-100 dB. The repeater's receiver must also be of very good quality, with substantial rejection a few kHz away from its center frequency.
=====

The receiver AND the transmitter must both be well-shielded and their power supplies isolated from each other.
=====

This is the main reason why simple HT's or mobile radios often make poor repeater radios. There are some exceptions, however, such as commercial-quality Motorola or similar radios.

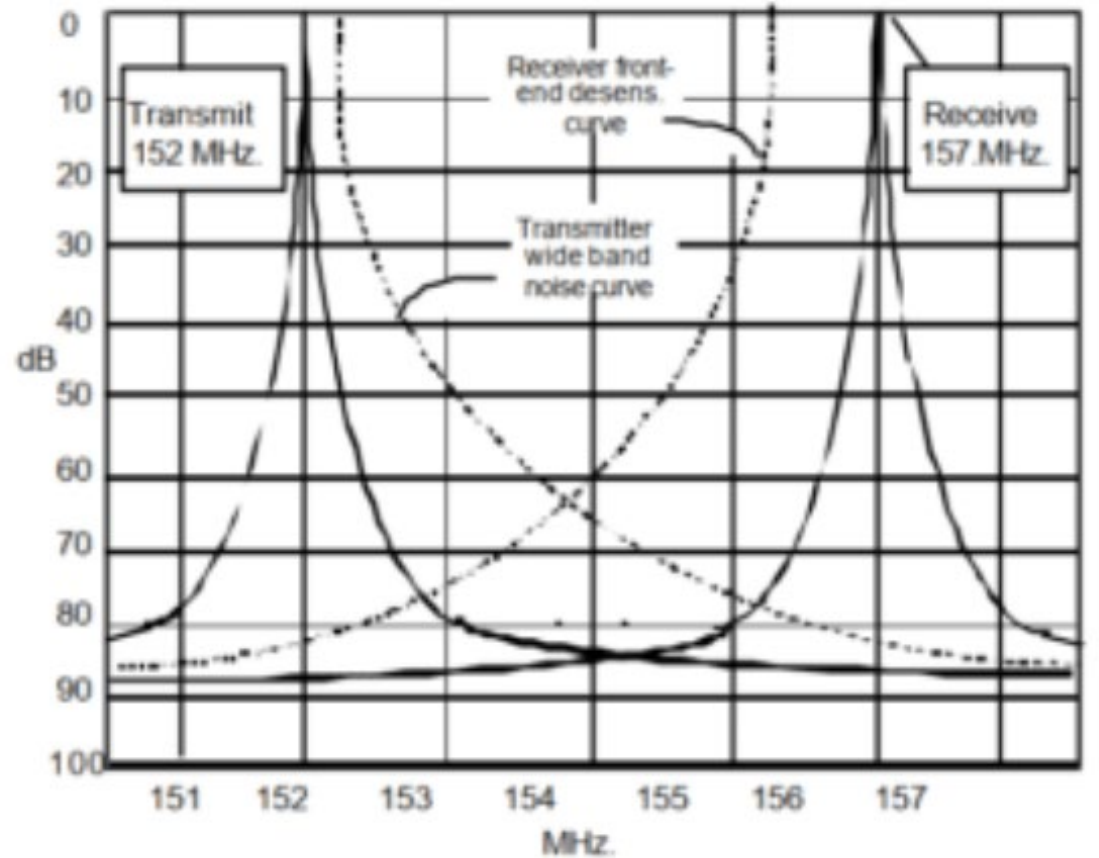

Band Pass Duplexer Response

Duplexers are Resonant Cavities, So They Are Roughly $\frac{1}{4}$ Wave Tall

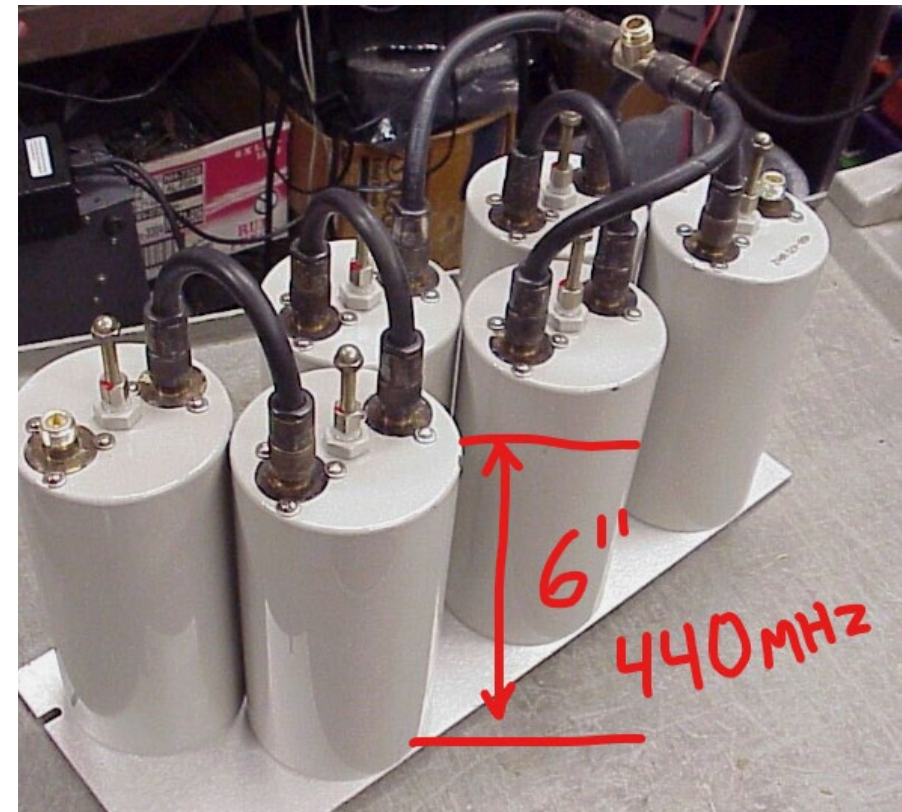

But What About the Retevis RT-97 GMRS Repeater-in-a-Box?

Portable radio signal relay base station —
let the signal be everywhere



Cheater!

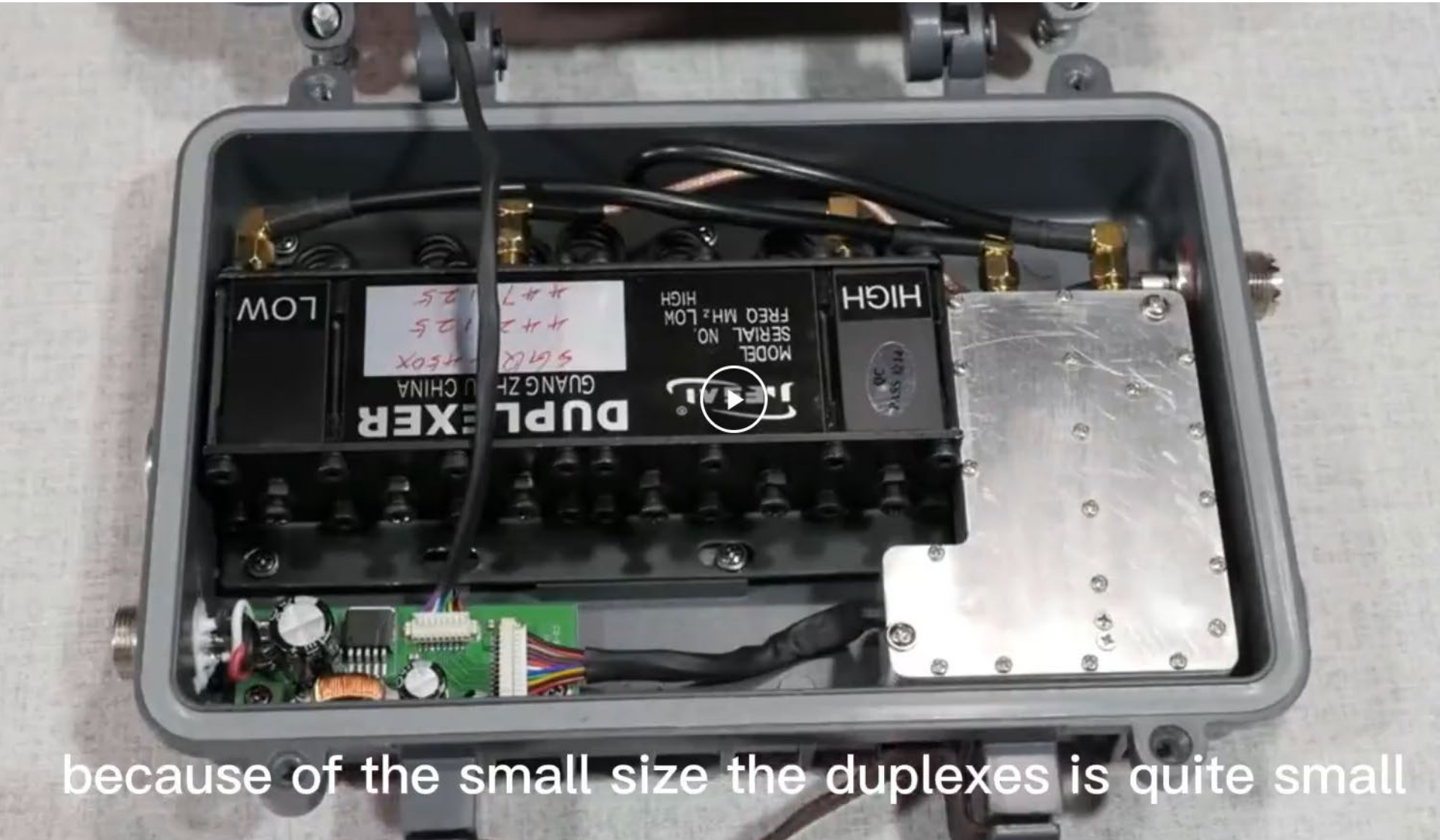

because of the small size the duplexes is quite small

“Mobile” Duplexers

- Often called “Notch-Notch” duplexers
- Quality repeater duplexers are always Pass-Pass (or Bandpass) type
- Notch-only types do not provide any out-of-band rejection or filtering
- They only reject the transmitter’s frequency at the receiver
- Their main advantage is small size and low cost
- Not suitable for power levels over maybe 10 watts (40 dBm)
- China is the main source now...of course

Right Now on Amazon!



UHF 400-470MHz 30W Duplexer for Radio Repeater with Preset Low Frequency 462MHz & High Frequency 467MHz & N Female connectors

★★★★☆ ~ 19

\$84⁹⁹ List: \$89.99

FREE delivery for Prime members

Add to cart



VHF 136-174MHz 30W Duplexer for Radio Repeater with Pre-Tuned Low Frequency 156MHz & High Frequency 163MHz & N Female connectors

★★★★☆ ~ 9

\$84⁹⁹

✓prime Two-Day

FREE delivery **Thu, Feb 22**

Only 10 left in stock - order soon.

Add to cart



Telewave - 144-174 MHz Duplexer (TPRD-1554)

Brand: Telewave Inc.

P\N: TPRD-1554

UPC: 729198253875

★★★★★ No Reviews yet

Availability: **In Stock**

Your Price: \$3,571.00

- 1 +

ADD TO CART

ADD TO QUOTE

Do you have questions?
Please contact our experts for assistance.

Live Chat

Contact Us

Call Our Experts



Telewave - 144-174 MHz Duplexer (TPRD-1556)

Brand: Telewave Inc.

P\N: TPRD-1556

UPC: 729198227418

★★★★★ No Reviews yet

Availability: **In Stock**

 Ships Within: **1 - 2 Business Days**

Your Price: \$5,745.00

- 1 +

ADD TO CART

ADD TO QUOTE

Do you have questions?

Please contact our experts for assistance.

 Live Chat

 Contact Us

 Call Our Experts

K7DAA 440
Repeater:
We Had to
Start
Somewhere







Cutting into
the Hillside,
Building a
Foundation
and Retaining
Wall



The Finished Repeater



Dealing with Various Environmental Issues (or Where Eagles Dare)



View From Above the Repeater





Inside The Box

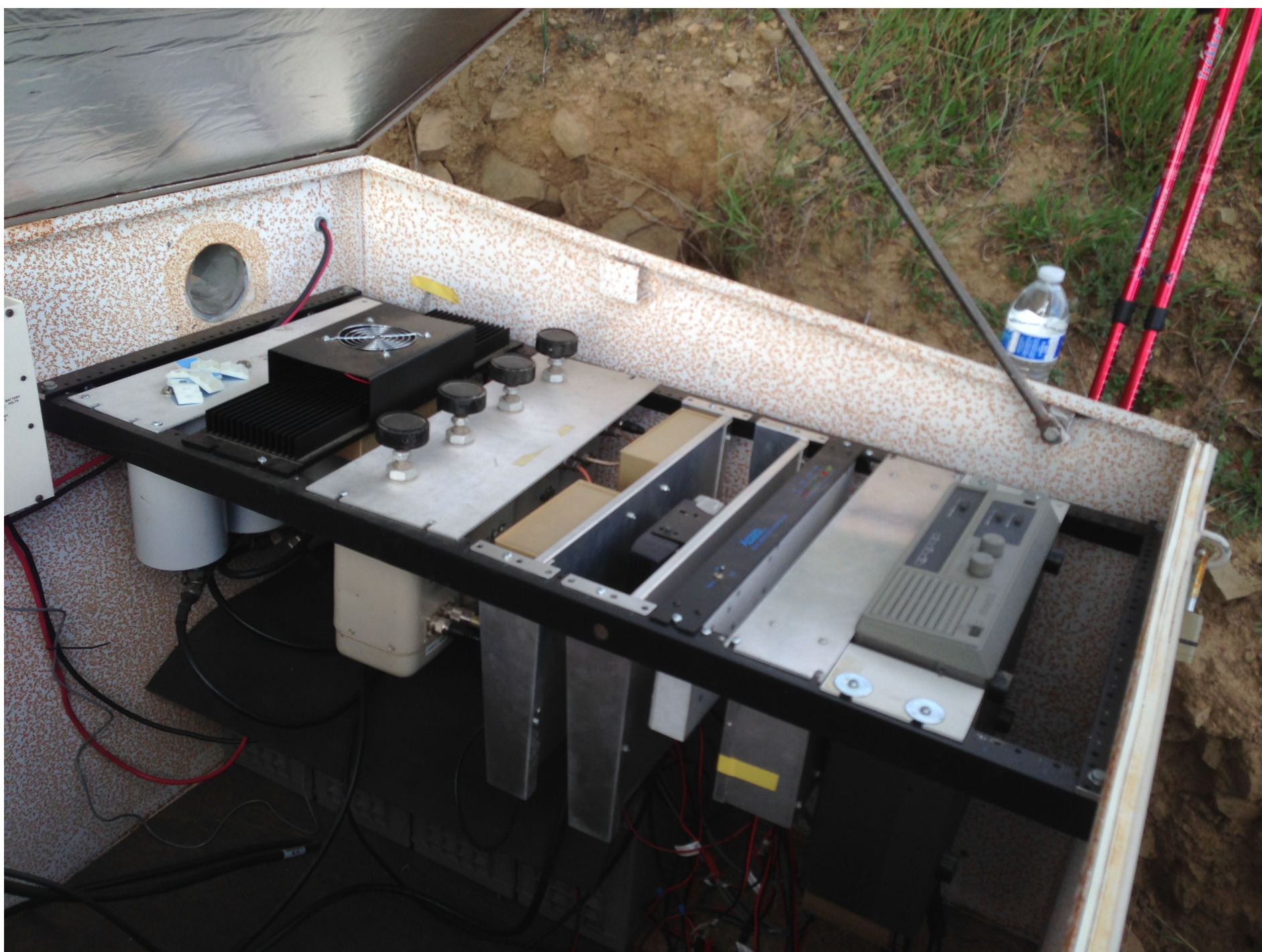

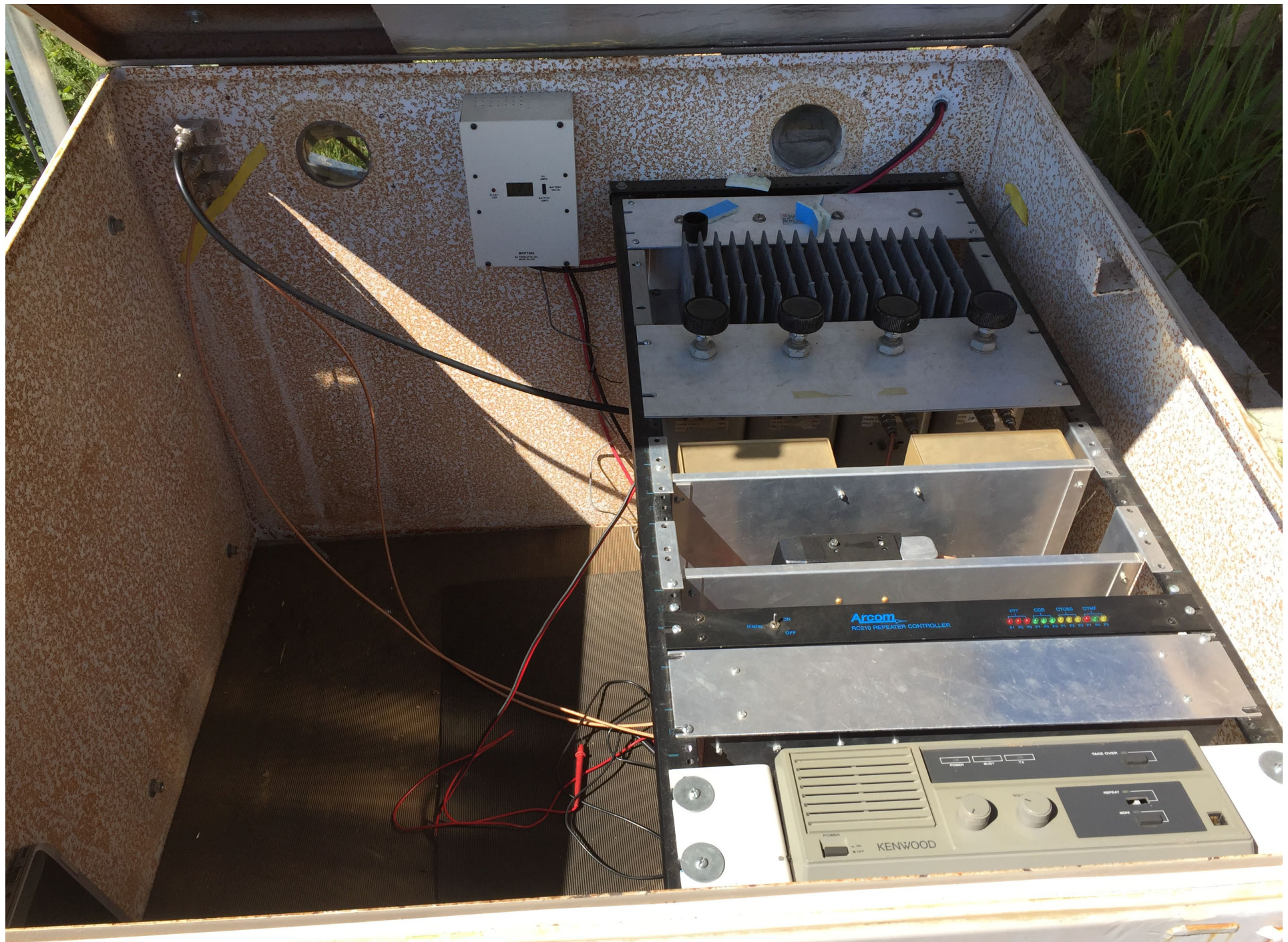

Detail of
Lightning
Arrestors and
1 of 4 Vents





Batteries & Bus Bars

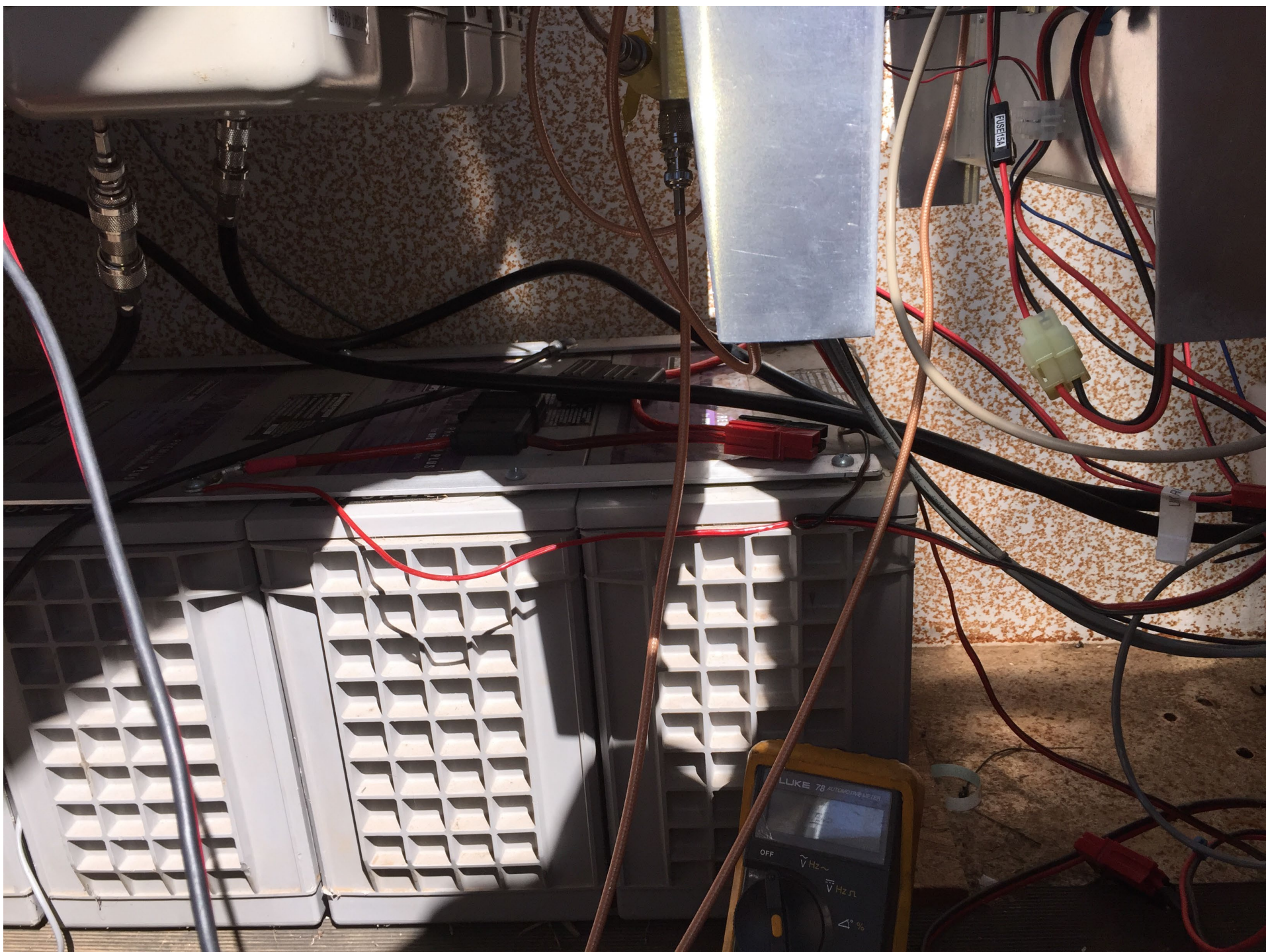

The 2 Meter
Repeater
Came First
in 2006

147.33 MHz
+600 kHz shift
103.5 Hz PL





4 + 2 = 6 "Cans"
Duplexer for
147.33/147.93
Repeater



The 2 Meter Repeater's Future Home



